



art metal

G02 MARS LED

F.P.H. Art Metal Sp.j.

Ul. Jabłoniowa 124, 83-331 Łapino Kartuskie, Poland
 Tel. 0048 58 681 80 78, Fax: 0048 58 681 80 64
 www.art-metal.pl e-mail: biuro@art-metal.pl

Construcion:

The unit consists of a metal basket (1) holding a shade (2). A disk (4) separating electrical compartment from lighting compartment is attached to a luminary basket (1) on the top. A LED light source radiator (6) is mounted to the disk (4). LED module is mounted to the radiator (6) a tightly closed with a lens (5). Module is powered with a voltage power supply (7). The luminary cover (3) is mounted to the luminary body (1) with a hinge and closed with a screw so no additional tools are necessary. The luminary is sealed with a gasket (8).

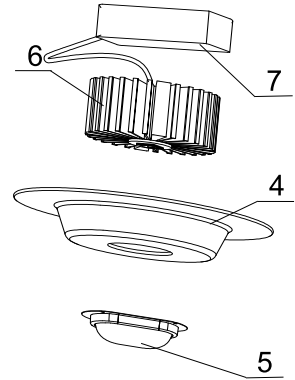
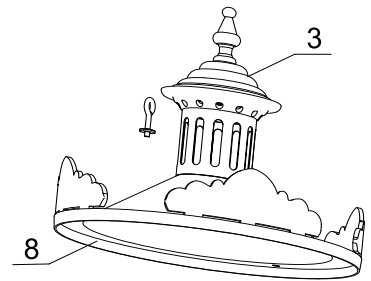

Mounting instruction:

- *)- Put the shade (2) into the basket (1)
- *)- Screw the radiator (6) to mount an LED light source to the disk (4)
- *)- Screw tightly disk (4) to the luminary basket (1)
- Connect the electrical cables to the terminals of power supply (7)
- Close the cover using hand.
- Luminary is mounted to the lantern depending on the pole construction - either hanging on M20 thread or mounted on the top of the pole on $\varnothing 45\text{-}\varnothing 90$ diameter.

If any lantern elements are supplied factory-mounted, the mounting stages marked with *) should be omitted (as this has already been done by the manufacturer).

TECHNICAL DATA:

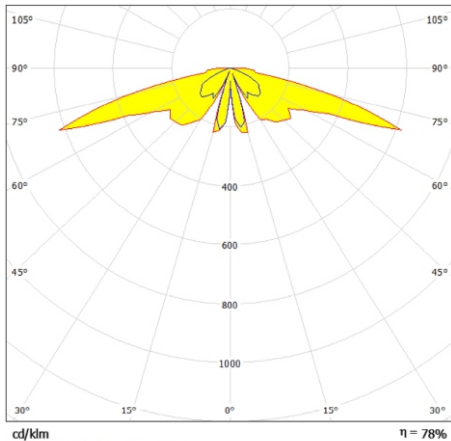

Photometry (polar plot)

Power: ~230/50Hz

Protective class: I

IP65 -electrical part

IP65 -optical part

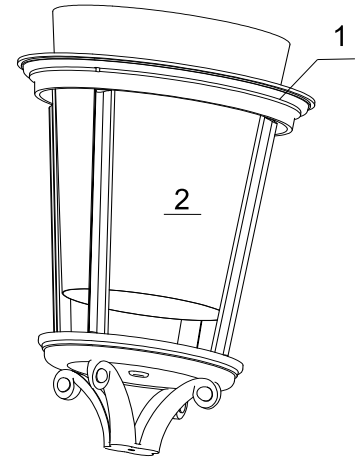
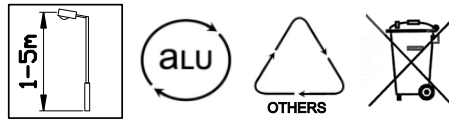

ELECTRICAL DIAGRAMS:

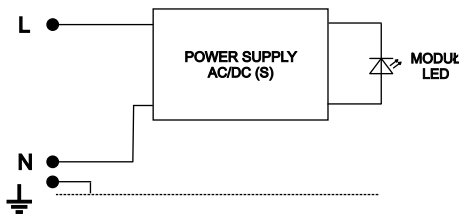

1. Module LED -basic power supply (S)

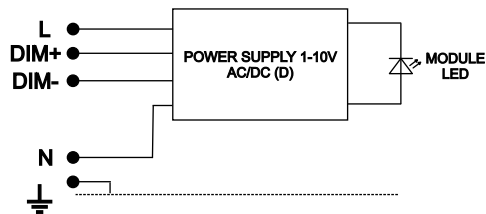

2. Module LED -dimmable power supply (D)

Type	Light-prod. element	Luminous flux [lm]		Weight [kg]	Pn [W]	Luminary dimensions
		3000K (830)	4000K (840)			
G02L-22W	CXB2540	2990	3170	9,5	22	 Wind area $A = 0,15\text{m}^2$ H/D 660/380
G02L-33W	CMA2550	4286	4609	9,5	33	
G02L-38W	CMA2550	4842	5207	9,5	38	



WARNING !! The weight of the unit may slightly differ for individual production batches.

